

1

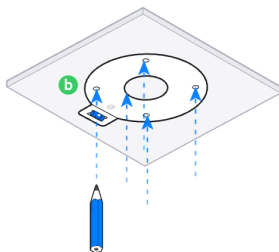

2

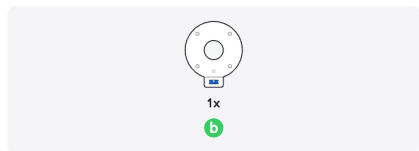

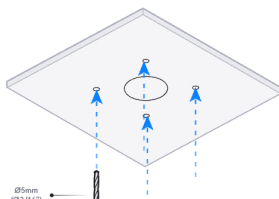
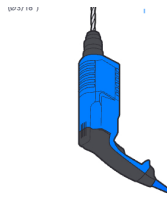

3

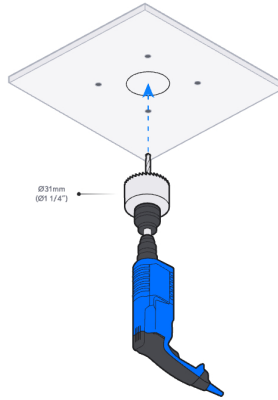

4

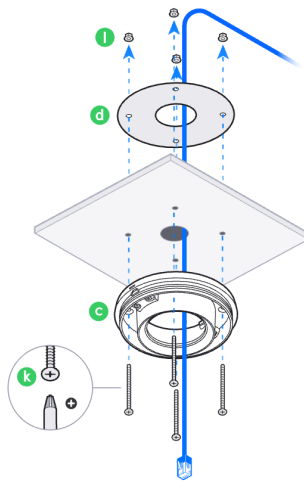
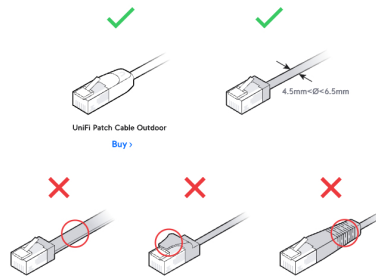
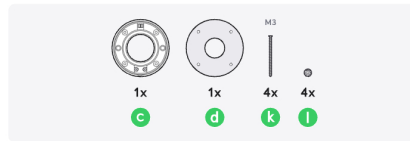

5

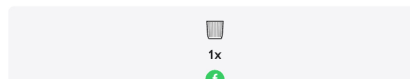

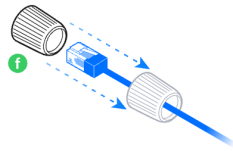

6

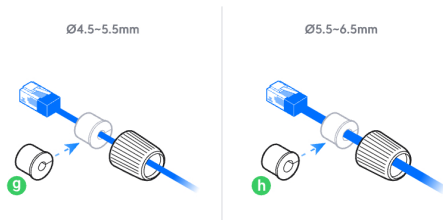
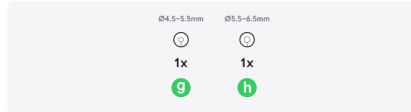

7

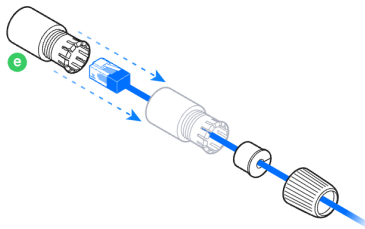

8

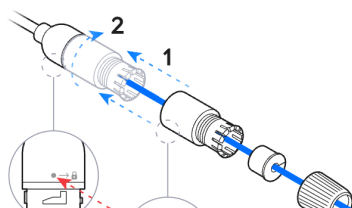
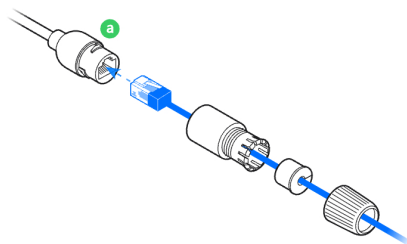
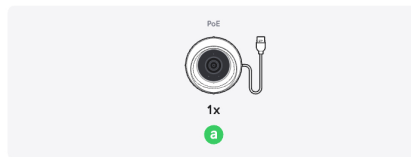

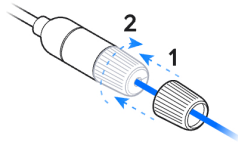
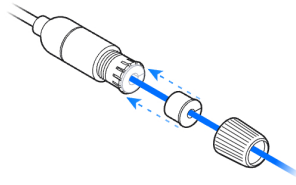
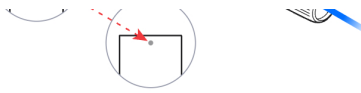

9

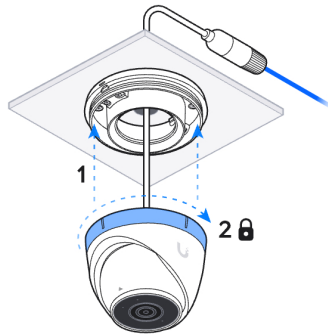

10

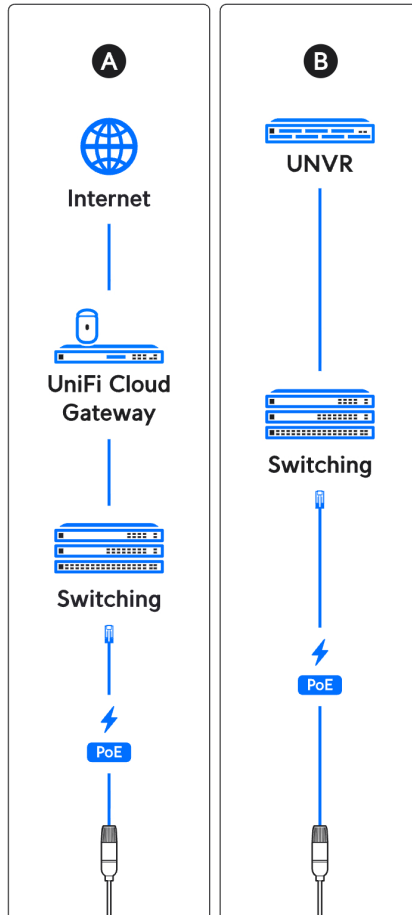

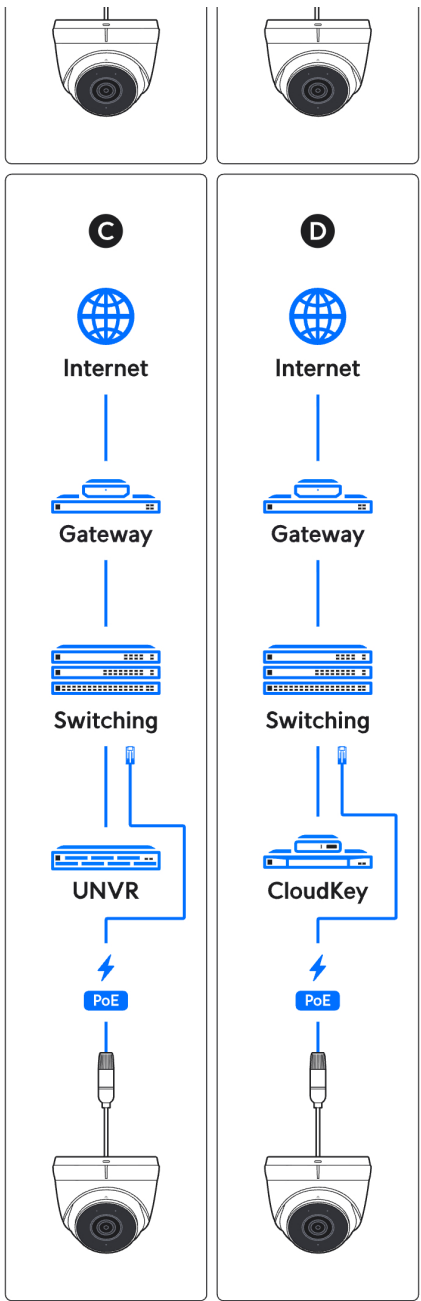

11

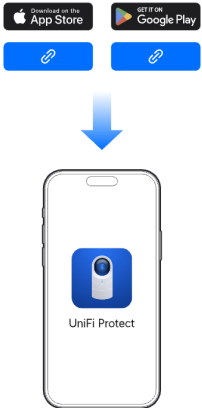

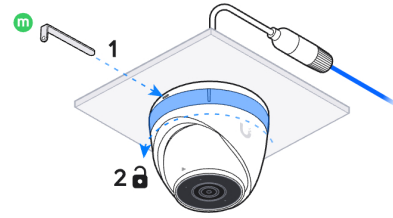
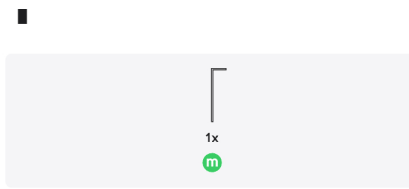

2

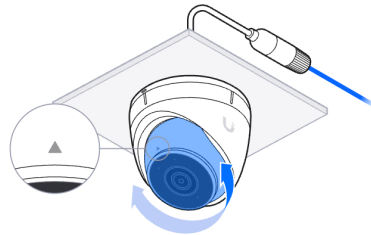
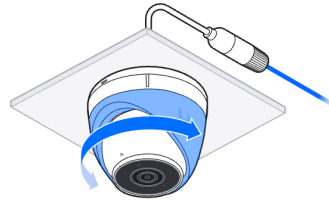

3

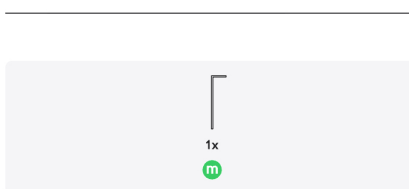

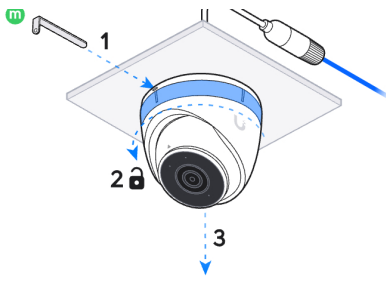

If you need further assistance, visit our [Help Center](#) or contact [Ubiquiti Support](#).

©2024 Ubiquiti Inc. All rights reserved. Ubiquiti, the Ubiquiti logo, UniFi, UniFi Protect, and UniFi are trademarks or registered trademarks of Ubiquiti Inc. in the United States and in other countries. Apple and the Apple logo are trademarks of Apple Inc., registered in the U.S. and other countries. App Store is a service mark of Apple Inc., registered in the U.S. and other countries. Android, Google Play, and the Google Play logo are trademarks of Google LLC.